



EXTENDED TARGET WEIGHING APPROACH - IDENTIFICATION OF LIGHTWEIGHT DESIGN POTENTIAL FOR NEW PRODUCT GENERATIONS

Albers, Albert; Revfi, Sven; Spadinger, Markus
Karlsruhe Institute of Technology (KIT), Germany

Abstract

In the development process of vehicles, especially electric vehicles, lightweight design becomes more and more important. Lightweight design efforts often result in increasing costs of a product and are thus mainly reserved for vehicles in the premium sector. The presented paper suggests the extension of the Target Weighing Approach, which was proposed to match mass and function, based on the systematic approaches of target costing and value engineering. This approach allows the identification of where the most promising weight reductions could be achieved. The Extended Target Weighing Approach includes a new methodical procedure which allows to analyse systems existing of only one single component by matching the functions to their functional areas. Furthermore, the analysis of potential of the current product generation and new concepts for the next product generation are extended by the dimensions CO2 footprint and costs. Additionally, a method to evaluate the uncertainties related to new concepts is proposed.

Keywords: Conceptual design, Early design phases, Design methods, Lightweight design, Target Weighing

Contact:

Prof. Dr.-Ing. Albert Albers
Karlsruhe Institute of Technology (KIT)
IPEK Institute of Product Engineering
Germany
albert.albers@kit.edu

Please cite this paper as:

Surnames, Initials: *Title of paper*. In: Proceedings of the 21st International Conference on Engineering Design (ICED17), Vol. 4: Design Methods and Tools, Vancouver, Canada, 21.-25.08.2017.

1 INTRODUCTION

Rising demands regarding safety, interior functions, quality, comfort and environmental standards entail increasing vehicle weights. For the development of vehicles with electrified drive trains, it is essential to reduce the overall vehicle weight in order to operate on long distances. This results in tensions which, in many cases, are faced with lightweight design efforts.

Lightweight design solutions often come at high costs. This is a result of many factors: e.g. expensive new materials, need for new production processes and machines, etc. Therefore, affordable lightweight design is one of the most challenging tasks that OEMs as well as their suppliers need to overcome especially in the fields of high-volume market. In addition, efforts reducing the mass of a vehicle often focus on and are limited to single components or parts. Weight targets are mostly set to departments, responsible for modules and thus their achievements are limited to the boundaries of the system they are focusing on.

Furthermore, environmental aspects like the CO₂ footprint of an individual component are usually not considered in the early design phase. But as the environmental impact becomes more and more important - especially the CO₂ footprint during the complete product lifecycle - there is a need for holistic methods which take these factors already in early phases of the development process into account.

For this reason, the partners of the project 'AffordabLe LIghtweight Automobiles AlliaNCE (ALLIANCE)' attend this problem. Their aim is not only the development of new innovative lightweight materials and manufacturing technologies but also the applicability in a close horizon for the upcoming vehicle models after project completion.

Part of the project is to face this challenge on a methodical level in order to find a systematic procedure for future developments. A possible approach to identify lightweight design potential is the Target Weighing Approach. This approach focuses on weight reduction based on a component-wise functional analysis in early phases of the product development. To achieve future development targets, holistic approaches which not only address lightweight design but also CO₂ emission and costs at the same time become necessary.

As a part of the ALLIANCE project a novel cross-component approach called 'Extended Target Weighing Approach' is used to reveal lightweight design potential and to balance costs and CO₂ emissions on a functional level at the same time. Besides, a need for a methodical change of the way the functional analysis is performed has been noticed: For products with a small amount of components it is more promising to separate the few components into functional areas. In doing so, it becomes even possible to optimise single components.

2 STATE OF THE ART

In the following sections the approaches, which will be applied in ALLIANCE, will be introduced briefly to provide a basic understanding of them. They had been developed and applied during the last years in several use cases.

2.1 PGE - Product Generation Engineering

Most of newly developed products are based on existing reference products. These can be specific predecessor systems, technology carrier or products of a competitor in an existing market segment and are improved in an evolutionary way. The Product Generation Engineering (PGE) describes the development of new product generations according to their changes in design, material and manufacturing technology.

In order to be able to quantify the risk of a new product and to reduce the development costs, the degree of novelty should be identified by subsystems that have been newly developed and by subsystems that are carried over. The development of new subsystems can be performed either by varying the principle or the variation of embodiment. By varying the principle, a change in the embodiment always becomes necessary (Albers et al.; 2015, 2016a, 2016b).

A new product generation (G_{n+1}) consists of subsystems (SS) with carry over variations (CV), embodiment variations (EV) and principal variations (PV):

$$CS_{n+1} \{SS | CV_{(SS)}\}; ES_{n+1} \{SS | EV_{(SS)}\}; PS_{n+1} \{SS | PV_{(SS)}\} \quad (1)$$

$$G_{n+1} = CS_{n+1} \cup ES_{n+1} \cup PS_{n+1}. \quad (2)$$

Choosing the share of each variation type, which can be calculated as stated in Equation (3), in the planning phase and controlling those shares during the development process of a product allows analysing risks and to control validation activities (Albers et al., 2014a).

$$\delta_{CV n+1} = \frac{|CS_{n+1}|}{|G_{n+1}|} = \frac{|CS_{n+1}|}{|CS_{n+1} \cup ES_{n+1} \cup PS_{n+1}|} \quad [\%] \quad (3)$$

This modern classification is contrary to classical design methods as described in Pahl et al. (2013) which state three different types of engineering projects: new construction, adjustment construction and variant construction. According to Eckert et al. (2010) and Deubzer and Lindemann (2009) newly developed products contain only small and as little as possible adjustments of already existing solutions.

2.2 Contact & Channel² - Approach (C&C²-A)

Based on the work of Albers et al. (2008), Albers and Wintergerst (2014b) revealed that there is a need for a modelling approach attending the issue that engineers have trouble with the analysis of concrete products in abstract terms. Therefore, the Contact & Channel² - Approach provides a common modelling language with a clear description of the functions of a product. A product can only fulfil a function if its components interact with its environment. So there are two important factors a design engineer has to focus on: the interfaces between the physical structure and the environment as well as the physical structures itself. Not all interfaces and physical structures have to perform a function all the time. That can depend on the operating state of the product.

For an appropriate description of a function in the Contact & Channel² - Approach a distinction between

- Channel and Support Structures (CSS)
- Working Surface Pairs (WSP) and
- Connector (C) modelling elements is needed (Albers and Wintergerst, 2014b).

In order to fulfil a function at least two Working Surfaces coupled to one Connector each and connected by a Channel and Support Structure are necessary. The so-called Wirk-Net consolidates all CSS, WSP and Cs which are performing a function in a certain operating state. Figure 1 illustrates the Contact & Channel - Approach (including the Wirk-Net) by the example of a screw, which is drilled into a wall. However, this is just one possible way of description. By focusing on the head of the screw for example, it is also possible to describe the Wirk-Net shown in Figure 1 in a more detailed view. It is always necessary to choose an appropriate resolution for the description. As the level of detail can be chosen freely, there is the risk that the description becomes too detailed for the given task.

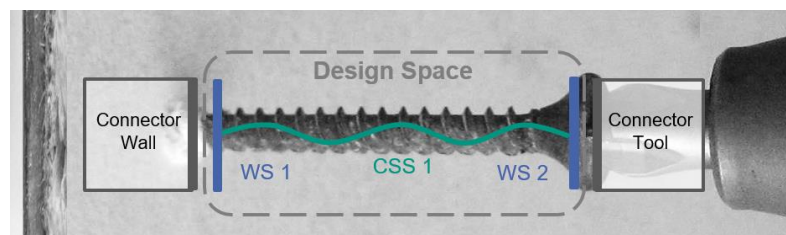

Figure 1. Contact & Channel² - Approach exemplified by a screw (according to Albers and Wintergerst (2014b))

2.3 Component-Based Target Weighing Approach

Albers et al. (2015c) showed that holistic approaches are necessary to develop new products with low mass. The Target Weighing Approach, as proposed by Albers et al. (2013), is such an approach which allows determining lightweight design potentials during the development process of new product generations based on predecessor systems. The Target Weighing Approach is founded on the two systematic methods "Value Engineering" (VDI 2800, 2010) and "Target Costing" (Kato, 1993; Zengin and Ada, 2010). The basic idea of Value Engineering is to assign value to a specific function and to increase this value without creating any additional costs (Ibusuki and Kaminski, 2007).

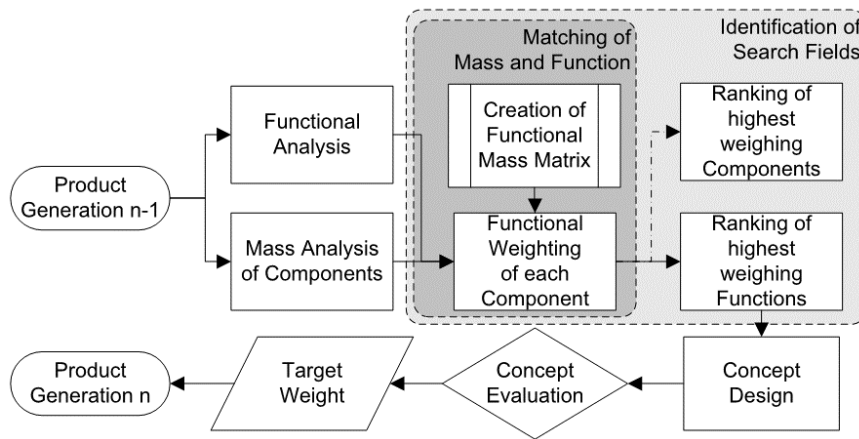

Figure 2. Workflow of Target Weighing Approach, according to Albers et al. (2015c)

The Target Weighing Approach abstracts this idea and assigns mass to a function. Figure 2 shows the workflow of the Target Weighing Approach. An approach which also is based on functions, mass, mass distribution and the mass moment of inertia and creates target values for the mass during the analysis phase had been introduced and applied by Posner et al. (2012, 2013, 2014).

In the beginning, a functional analysis is performed where the product is analysed in a holistic way to derive all functions performed by the product. This functional analysis is one of the core activities and needs to be performed carefully as this analysis is typically quite complex. However, this analysis serves as a basis for all following steps. In order to get a functional overview of complex systems, it is important to analyse the product in a systematic way. The Contact and Channel² - Approach (C&C²-A) helps to identify all functions. In the context of the Target Weighing Approach, it has to be differentiated between main functions (essential for the product functionality), sub functions (responsible for additional functions) and auxiliary functions (very detailed description compared to the main functions). The results can be illustrated in a tree diagram. Figure 3 shows the result of a functional analysis of a gearbox housing. The more extensive the functions of the product are identified, the better is the result gained through the Target Weighing Approach.

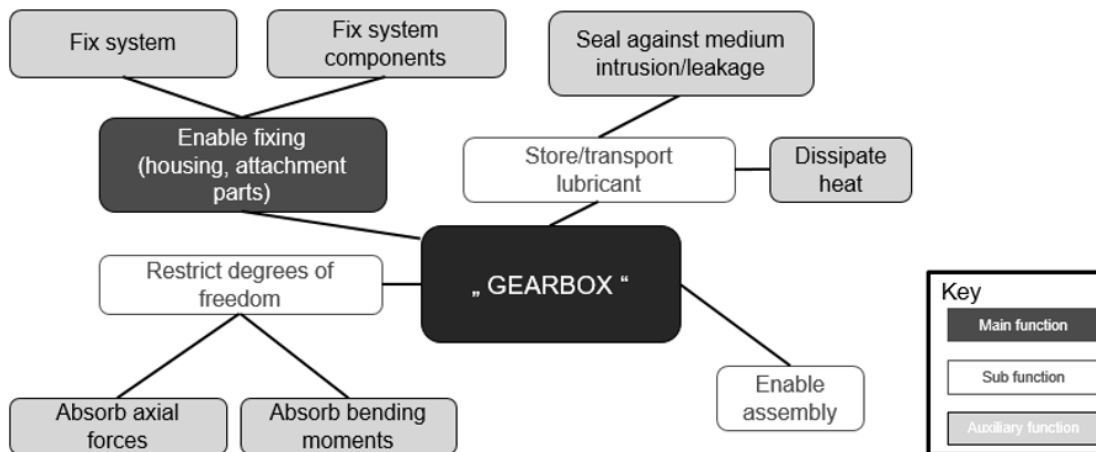

Figure 3. Tree diagram (exemplified by functions of a gearbox)

For the component-based approach the individual components of the product and their mass have to be determined e.g. from the CAD data tree.

In order to create the Function-Mass-Matrix the components are listed on the vertical axis and the functions are listed on the horizontal axis. In the next step, each component is assigned a percentage to the fulfilment of the functions (see Figure 4). This estimation has to be done by a group of experts as it is essential for the result of the method. A proper Function-Mass-Matrix is crucial to identify the heaviest functions and serves as a basis for further evaluation. The result of this activity is the mass per function.

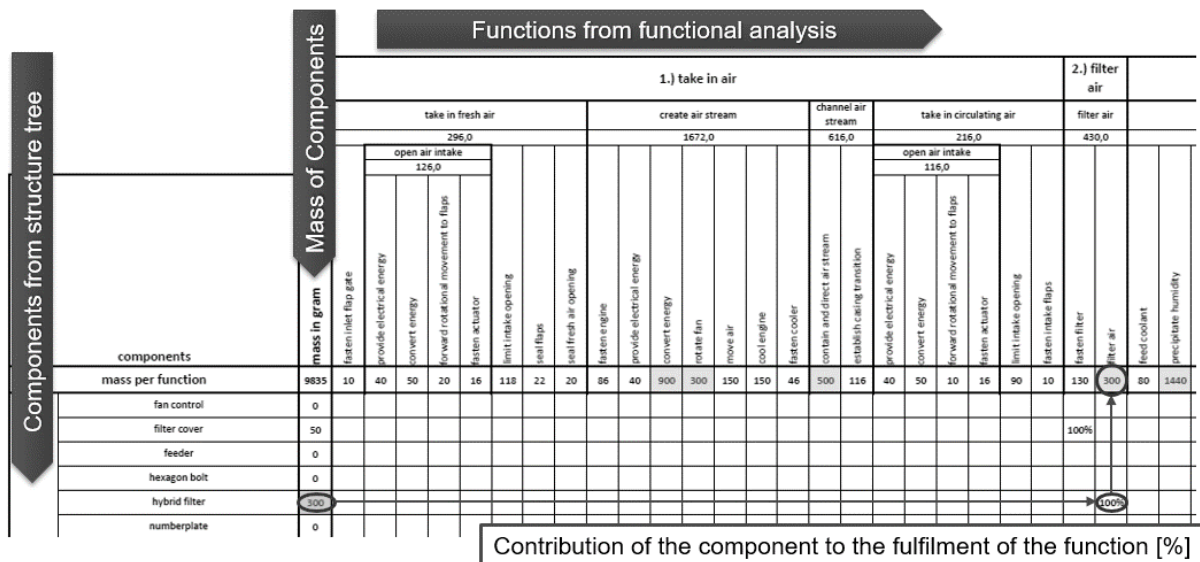

Figure 4. Function-Mass-Matrix (according to Albers et al.,2013)

The next step is a paired comparison in order to derive the relative importance of each function. In doing so, a prioritisation of functions is gained and can be adjusted to internal and external customer needs. Plotting the weight of each function against its relative importance leads to a function portfolio that allows the identification of lightweight design potential. Another way to identify lightweight design potential is the use of an ABC-Analysis. With the help of this method, it is possible to visualise the weight of functions in descending order. As an example, Figure 5 shows a function portfolio and the result of an ABC-Analysis.

Sector A contains the heaviest functions with the highest lightweight design potential. In order to reduce the weight of specific functions, it is possible to think about either integration of functions or separation of functions. Less important functions in sector B offer lightweight design potential too.

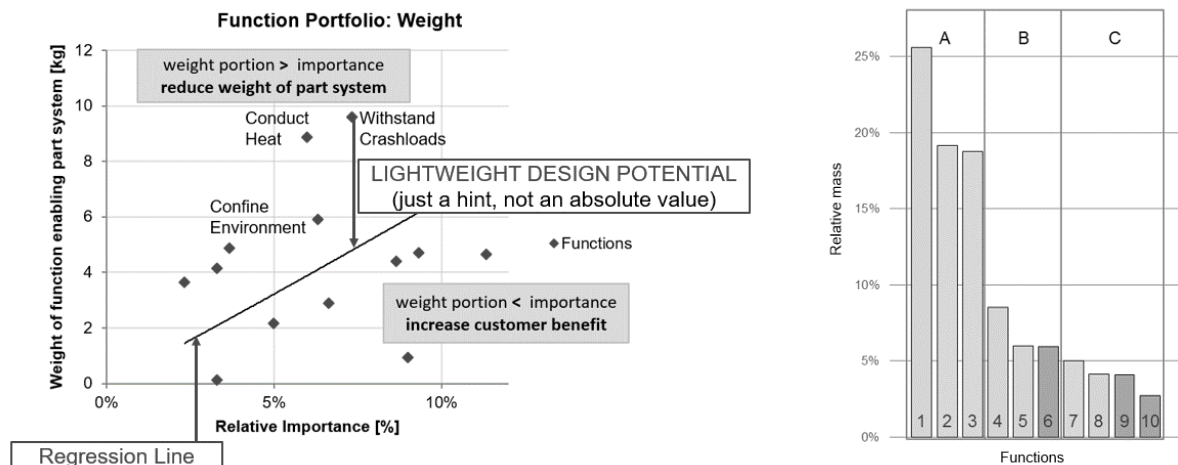

Figure 5. Function Portfolio (according to Albers et al.,2013) and ABC Analysis

Based on the identified search fields, new ideas are generated and new concepts are developed. Methods like Brainwriting (e.g. 6-3-5 method), TRIZ (Herb et al., 1998) and World-Café can be used in order to generate a large number of ideas. This step is followed by a preselection of the most expedient solutions. In the context of preselection, the ideas have to be checked with regard to project objectives, physical laws and technical feasibility. The result of this step are sketches and concept descriptions which serve as a basis for the estimation of their mass.

Using the Function-Mass-Matrix in reverse direction helps to understand the impact of a new idea on the product. Changing one parameter may affect others. Adding one component may reduce the weight of other components. So different dependencies can be shown. This step is called 'Sensitivity Analysis'.

Thus, the Target Weighing Approach is a function-based approach that enables the user to identify search fields for further investigation without focusing on single components. Since several components typically contribute to one function, the Target Weighing Approach is a cross-component method. One goal of the ALLIANCE project is to extend the Target Weighing Approach in order to match future challenges regarding environmental and costing demands.

3 EXTENDED TARGET WEIGHING APPROACH

The state of the art Target Weighing Approach, as shown above, showed great potentials during industry projects (e.g. Wagner, 2015) on products which consist of several components and parts to which the functions can be assigned directly. However, a lot of systems under development consist of a single component such as housings and structural parts. Also, due to the high complexity of systems and their environment, the mass of a certain component is not the only parameter during decision making processes. In terms of environmental concerns, uncertainties regarding recent knowledge and increasing cost pressure, it becomes necessary to evaluate new concepts with respect to CO₂ footprint, costs and mass in parallel. Nevertheless, there are always uncertainties related to those dimensions which have to be taken into account.

For these reasons, the Target Weighing Approach needs to be extended in order to analyse an existing product generation which consists of only little or one single component(s). This has to be done in relation to the dimensions, mass, CO₂ footprint and costs. In addition, with the Extended Target Weighing Approach it needs to be possible to evaluate concepts for new product generations regarding those three dimensions and to select the most suitable for the desired functions under consideration of the linked risk.

In order to validate the extension of the Target Weighing Approach and to achieve a high acceptance in industry, a high volume and cost-driven demonstrator component representing the recent product generation - provided by Adam Opel AG - is used. The demonstrator comprises two submodules, the strut tower with the wheel house and the rail from a C-segment car. For identifying lightweight design potentials of the strut tower and the wheel house, the Extended Target Weighing Approach in its Component-Based version is used, whereas for the rail the Functional-Area-Based approach is applied. The components can be seen in Figure 6.

In the later stage of the project the Extended Target Weighing Approach is transferred to the demonstrators of other OEMs in the consortium which serve as case studies for further validation of the new approach.

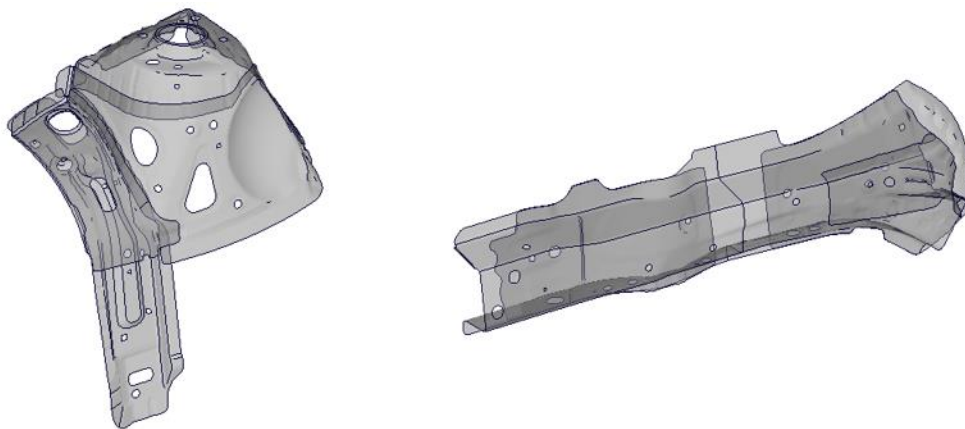

Figure 6. Strut tower with wheel house and rail (Adam Opel AG)

The extension of the Target Weighing Approach embodies one main goal of the project. In the following, a short overview regarding the proposed procedure for the Extended Target Weighing Approach will be presented. Thereby, the basic steps remain the same, as introduced above (Figure 2). Afterwards, the workflow and necessary steps to match the mass of a system, existing of only one single part, to the functions during the so-called Functional-Area-Based Target Weighing Approach, are introduced. Furthermore, the proposed integration of the costs, estimated through a green-field approach, and the CO₂ impact, estimated by a Life-Cycle-Assessment, will be presented.

3.1 Proposed procedure

The proposed procedure basically remains the same as shown in Figure 2. Additional effort has to be spent in order to gather cost and CO₂ emission data which is then assigned to the identified functions based on the contribution of the components or functional areas to the function fulfilment. In doing so a Function-Effort-Matrix is created.

The assignment of mass, costs and CO₂ emission can either be done Component-Based or Functional-Area-Based. The latter is a new approach which is helpful if the product only consists of a small amount of single components. This approach is explained in detail in the following section.

Evaluating the Function-Effort-Matrix with the help of an accumulated bar diagram leads to promising search fields for lightweight design. The evaluation strategy is described more precisely in section 3.3. Based on the identified lightweight design potentials, new concepts can be developed and evaluated similarly to the presented procedure in Figure 2.

3.2 Functional-Area-Based Target Weighing Approach

Using the Functional-Area-Based approach may be appropriate if there are not enough single components. Then the components are divided into areas in which functions are fulfilled.

In the following the Functional-Area-Based Target Weighing Approach is introduced by the example of a gearbox housing as shown in Figure 7. The functions of the underlying gearbox housing are shown in Figure 3. They have been determined one step ahead in the exact same manner as the functions were derived for the Component-Based approach.

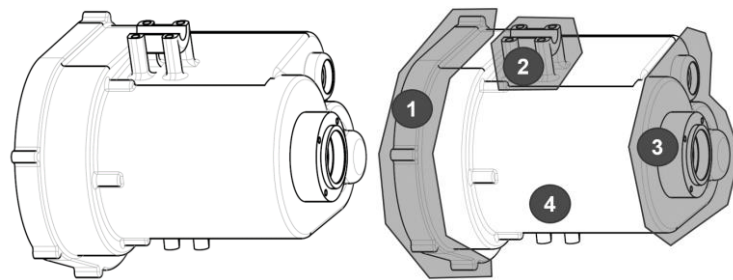

Figure 7. Gearbox and Gearbox with functional areas

The next step is to identify the areas of the product in which the functions are fulfilled. The most systematic way is to go through all defined functions and to mark the area which is crucial to fulfil the respective function. In doing so, all the functional areas can be determined. As an example the functional areas of the gearbox example are shown in Figure 7. It is distinguished between four areas. Section 1 enables the assembly of the gears and the fixing of system components. Section 2 enables the fixing of the gearbox housing at the frame. Section 3 absorbs bending moments and axial forces as well as enables the fixing of system components. Section 4 mainly dissipates heat and seals against medium intrusion/leakage. Having completed the allocation of the functional areas, the areas are assigned a percentage to the fulfilment of the functions to derive the mass per functional area.

3.3 Integration of costs and CO₂ emissions

In order to consider the costs of the actual product generation and to evaluate them in comparison with newly generated rough concepts during the early phase of the product development process, greenfield costs will serve as a basis. This allows comparing concepts without considering existing infrastructure. The Extended Target Weighing Approach aims to derive costs per function in a similar way as the mass per function is determined. With this additional data the Function Portfolio is expanded by an additional dimension. The result is a point in a three dimensional graph with relative importance, weight and cost of a function as x-, y- and z-axis.

CO₂ emission data, out of a Life-Cycle-Assessment can be integrated in the same way. To obtain reliable results, detailed information about the used materials, the manufacturing processes, and the life cycle of the submodule, including recycling, need to be provided. This investigation should result in a CO₂ footprint per component or functional area which can be then assigned to the particular functions. Afterwards the gained data is implemented to the existing Target Weighing Approach in the same way as described before for the costs.

A second conceivable procedure is that in an ABC-Analysis the costs or the CO2 emissions are plotted against the function for the purpose of getting a quick overview of the most expensive functions respectively the functions with the highest accompanying CO2 emissions.

But evaluating the data as described before does not result in an overview that shows direct dependencies between mass, costs and CO2. In order to combine these three factors, another possibility is to sum up the mass, costs and CO2 percentage rates per function. In doing so, a value that respects all three dimensions can be calculated and allows a comparison between the functions. Figure 8 shows a possible bar diagram of the aforementioned percentage rates per functions. Using this kind of plot allows the tracking of the influence quantities and their contribution to the final value. This enables the user to decide which quantity needs to be optimised. In this approach, it is also possible to rank the functions not only according to their highest value but also to their relative importance.

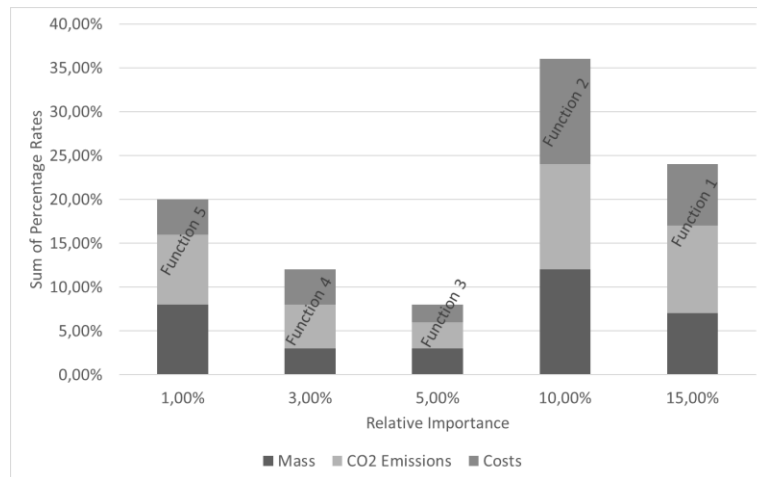

Figure 8. Ranking of percentage rate of mass, costs and emissions per function

3.4 Estimation of uncertainties

The Validation Prioritisation Approach, introduced by Albers et al. (2014c), is a method which allows prioritizing the validation activities for new product generations. The Validation Prioritisation Approach

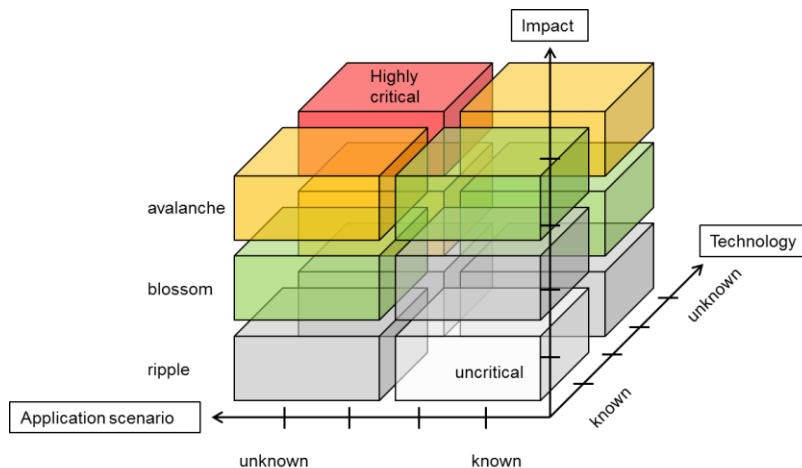

Figure 9. Criticality of concepts Albers et al. (2015c)

is based on the idea that the most critical subsystems have to be validated first. This methodical approach is adapted and integrated into the framework of Target Weighing Approach, to determine the uncertainties of the dimensions mass, costs and CO2 impact. The accompanying risk is described by the criticality which is defined by the three factors "Technology", "Application Scenario" and "Impact". By rating those three factors, designers are able to estimate the criticality of a certain solution supporting the decision for the right conceptual solution (see Figure 9).

The factor "Technology" is determined by the necessary production technologies and the technology of the underlying principle and needs to be rated from known to unknown by discipline-specific

professionals. The "Application Scenario" is rated from known to unknown, too. "Technology" and "Application Scenario" are often evaluated together and the designer can search for similar technologies already used in-house or for known application scenarios from predecessor systems. In addition to the basic evaluation of the criticality, the results of "Technology" and "Application Scenario" can also support the decision, whether the specific concept can be developed and produced in-house or if external expertise is required. Therefore, the evaluation results of the first two factors are case-sensitive and can be manipulated. The factor "Impact" determines, how the higher-level system is affected and if the consequences are tolerable.

3.5 The Extended Target Weighing Approach in the context of PGE

The Extended Target Weighing Approach represents a methodical approach to identify lightweight design potentials in a current product generation and allows evaluating and selecting concepts for new product generations. This approach not only supports design engineers during the early design phase but also allows controlling the product creation process by adding and evaluating detailed information on expected mass, CO₂ footprint and costs. This contributes to the classification into carry over variations, embodiment variations and principal variations. The systematic estimation of the uncertainties related to "Technology", "Application Scenario" and "Impact" makes a more differentiated evaluation of the accompanying risk possible. The dimensions mass, CO₂ footprint and costs as well as the three factors of the uncertainties relate to changes in design, material and manufacturing technology addressed by the Product Generation Engineering.

Furthermore, both procedures presented - the Component-Based approach exactly like the Functional-Area-Based one - can be adapted and used in the context of Product Generation Engineering in order to decide whether the changes of concept in the fulfilment of a desired function can be classified as principal variation or embodiment variation. By doing this, also the share of each variation can be calculated for each concept according to Equation (3). This can be done either by components or by functional areas whereby the latter can provide more detailed information.

4 CONCLUSION

With the Target Weighing Approach in its current state of the art, it is possible to identify search fields for lightweight design and to evaluate new concepts regarding to their expected mass. It does not consider costs and environmental impacts though.

The proposed Extended Target Weighing Approach includes the cost data as well as the CO₂ footprint and provides a method to estimate uncertainties. Evaluating the gathered mass, cost and CO₂ data in an accumulated bar diagram helps the user to identify lightweight design potential with regard to costs and CO₂ emission. By combining the Extended Target Weighing Approach with the ideas of the Product Generation Engineering and the Contact&Channel² - Approach, a holistic approach could be presented. Furthermore, the procedure presented based on functional areas meets the challenge of subsystems which do not consist of several components.

REFERENCES

- Albers A., Alink T., Thau S. and Matthiesen S. (2008), "Support of system analyses and improvement in industrial design through the Contact & Channel Model", *International Design Conference - Design 2008*, Dubrovnik, May 19-22 2008, The Design Society, Glasgow, p. 97-102.
- Albers, A., Bursac, N. and Wintergerst, E. (2015), "Product Generation Development-Importance and Challenges from a Design Research Perspective." *New Developments in Mechanics and Mechanical Engineering*, Vienna, March 15-17 2015, pp. 16-21.
- Albers, A., Reiß, N., Bursac, N. and Richter, T. (2016a), "The integrated Product engineering Model (iPeM) in Context of the product generation engineering", *26th CIRP Design Conference*, Stockholm, June 15-17 2016, Elsevier B.V., Amsterdam, pp. 100-105. <http://dx.doi.org/10.1016/j.procir.2016.04.168>
- Albers, A., Bursac, N. and Rapp, S. (2016b), "PGE-PRODUCT GENERATION ENGINEERING-CASE STUDY OF THE DUAL MASS FLYWHEEL.", *International Design Conference - Design 2016*, Dubrovnik, May 16-19 2016, The Design Society, Glasgow, pp. 791-800.
- Albers, A., Bursac, N., Urbanec, J., Lüdcke, R. and Rachenkova, G.(2014a), "Knowledge Management in Product Generation Development: an empirical study", *Design for X*, Bamberg, October 01-02 2014, TuTech Verlag, Hamburg, pp.13-24.

- Albers, A., Wagner, D., Ruckpaul, A., Hessenauer, B., Burkardt, N. and Matthiesen, S. (2013), "Target Weighing – A New Approach for Conceptual Lightweight Design in Early Phases of Complex Systems Development", *International Conference on Engineering Design 2013*, Seoul, August 19-22 2013, The Design Society, Glasgow, pp. 301-310.
- Albers, A., Burkardt, N. and Spadinger, M. (2015c), "System Oriented Lightweight Design – a Holistic Approach to Innovation", *The 3rd International Conference Mechanical Engineering in XXI Century*, Nis, September 17-18 2015, Faculty of Mechanical Engineering, Nis.
- Albers, A. and Wintergerst, E. (2014b), "The Contact and Channel Approach (C&C²-A): relating a system's physical structure to its functionality", In: Chakrabarti, A. (Ed.), Blessing, L.T.M., *An Anthology of Theories and Models of Design*, Springer, Heidelberg, pp. 151-171. https://doi.org/10.1007/978-1-4471-6338-1_8
- Albers, A., Klingler, S. and Wagner, D. (2014c), "Prioritization of Validation Activities in Product Development Processes", *International Design Conference - Design 2014*, Dubrovnik, May 19-22 2014, The Design Society, Glasgow, pp. 81-90.
- Eckert, C. M., Alink, T. and Albers, A. (2010), "Issue driven analysis of an existing product at different levels of abstraction", *International Design Conference - Design 2010*, Dubrovnik, May 17-20 2010, The Design Society, Glasgow, pp. 673-682.
- Deubzer, F. and Lindemann, U. (2009), "Networked Product Modelling - Use and Interaction of Product Models and Methods during analysis and synthesis", *International Conference on Engineering Design 2009*, Palo Alto, August 24-27 2009, The Design Society, Glasgow, pp. 371-380.
- Herb, R., Terninko, J., Zusman, A. and Zlotin, B. (1998), *TRIZ – der Weg zum konkurrenzlosen Erfolgsprodukt*, 1st ed., Modern Industrie AG, Landsberg/ Lech.
- Ibusuki, U. and Kaminski, P. (2007), "Product development process with focus on value engineering and target-costing: A case study in an automotive company: Scheduling in batch-processing industries and supply chains", *International Journal of Production Economics*, Vol. 105 No. 2, pp. 459-474. <https://doi.org/10.1016/j.ijpe.2005.08.009>
- Kato, Y. (1993), "Target costing support systems: lessons from leading Japanese companies", *Management Accounting Research*, Vol. 4 No. 1, pp. 33-47. <https://doi.org/10.1006/mare.1993.1002>
- Pahl, G., Beitz, W., Feldhusen, J., Grote, K.-H., Heusel, J., Bronnhuber, T., Hufenbach, W., Helms, O., Schlick, C., Klocke, F., Dilger, K. and Müller, R. (2013), "Gestaltungsrichtlinien", In: Feldhusen J., Grote, K.-H. (Ed.), *Pahl/Beitz Konstruktionslehre*, Springer, Berlin, Heidelberg, pp. 583-751. https://doi.org/10.1007/978-3-642-29569-0_12
- Posner, B., Keller, A., Binz H. and Roth, D. (2012), "Holistic Lightweight Design for Function and Mass: A Framework for the Function Mass Analysis" *International Design Conference - Design 2012*, Dubrovnik, May 21 - 24 2012, The Design Society, Glasgow, pp. 1071-1080.
- Posner, B., Binz, H., Roth, D., and others. (2013), "Operationalisation of the value analysis for design for lightweight: The function mass analysis" D. Society (Ed.), DS 75-5: Proceedings of the 19th International Conference on Engineering Design (ICED13).
- Posner, B., Binz, H., Roth, D., and others. (2014). "Supporting Lightweight Design Potential Assessment in the Conceptual Phase" D. Marjanović, M. Štorga, N. Pavković, & N. Bojčetić (Eds.), DS 77: *Proceedings of the DESIGN 2014 13th International Design Conference*.
- VDI 2800 (2010), *Wertanalyse*, Beuth-Verlag, Berlin.
- Wagner, D. (2015), *Methodengestützte Entwicklung eines elektrischen Energiespeichers zur Erschließung von Leichtbaupotenzialen als Beitrag zur Produktgenerationsentwicklung*, Karlsruhe Institute of Technology (KIT), Department of Mechanical Engineering, Forschungsberichte des IPEK - Institute of Product Engineering, ISSN 1615-8113.
- Zengin, Y. and Ada, E. (2010), Cost management through product design: target costing approach, *International Journal of Production Research*, Vol. 48 No. 19, pp. 5593-5611. <https://doi.org/10.1080/00207540903130876>

ACKNOWLEDGMENTS

This project has received funding from the European Union's Horizon 2020 research and innovation programme.