

## DESIGN FOR MANUFACTURING AND INTEGRATION OF MICRO-ELECTRO-MECHANICAL-SYSTEMS

Robert Watty, Hansgeorg Binz

### Abstract

MEMS technology deals with the integration of diverse micro technologies in complex and highly integrated systems under continuously developing boundary conditions. Successful development of MEMS demands a customised and rapid development process and requires attention to their special characteristics: technology-driven development, a wide range of manufacturing technologies and cooperation of experts of various fields. This paper suggests a possible development process and methodical support of designers by specific manufacturing guidelines and a new developed integration method to help experts of various fields to achieve efficient and effective development processes.

*Keywords: Methodology, Micro-Electro-Mechanical-Systems, Design for Manufacturing, Design for Integration*

### 1 Introduction

The market for MEMS (Micro-Electro-Mechanical-Systems) has grown around 20 % per year over the last decade and MEMS technology is predicted to be a key technology with enormous potential in the 21st century [1], [2]. MST (Micro-Systems-Technology) allows the production of such systems with extreme mechanical precision and high repetition accuracy. Typical products, e. g. sensors, are used in a broad variety of application fields from the automotive to the medical technology industry.

Despite the high investments in research and development of both new products and new production technologies, structured development processes for MEMS are not common practice.

The development of MEMS mass products is characterised by:

- interaction of diverse disciplines integrated in one product, e. g. micromechanics, micro-optics, microelectronics, biology or chemistry
- a wide range of production technologies and processes usually based on silicon or plastic, e. g. bulk micromechanics, surface micromachining, LIGA (from the initial letters of the German words for Lithography, Electroforming and Moulding) or MID (Moulded Interconnect Devices)
- a close interdependence between product and production technologies

The diversity of involved technologies, the close integration of components of diverse domains and the simultaneous development of product and manufacturing process influence the development process and require effective support of designers [3].

Information about limits and restrictions is often kept in the minds of individual developers and design rules for their special needs are quite unknown [2], [3]. A lack of knowledge of the

extent of the production possibilities often interrupts the product development process due to unavailable design rules to support the developer.

The integration of diverse domains and the interrelations between them require the incorporation of skilled specialists from different knowledge fields. Interrelations and interactions in highly complex systems must be considered in an appropriate way [4].

An extensive study of MEMS design by Klaubert [5] emphasises the need for guidelines for geometry, manufacturing and materials as well as assistance in the understanding of the entire system.

This paper discloses a basic MEMS design process supplemented by aspects of DFM (design for manufacturing) and establishes methodical support for DFI (design for integration) based on MID-technology.

## 2 Manufacturing of MEMS products

### 2.1 Materials

Basic condition for the development of MEMS is the knowledge of physical and chemical as well as manufacturing properties of the relevant materials.

The used materials are closely linked with MEMS manufacturing technology far beyond applied manufacturing technologies in disciplines like mechanical engineering or precision engineering. In addition, further factors e. g. the biocompatibility of implants, play a major role for the choice of suitable materials for MEMS. Thus MEMS designers require more information about manufacturing and material aspects than macro designers [5].

MEMS engineering comprises a multiplicity of materials out of diverse materials groups as shown in table 1.

Table 1. Materials used in MEMS technology [6]

Semiconductors	Si, Poly-Si, GaAs, SiC, diamonds
Dielectric materials	SiO <sub>2</sub> , Si <sub>3</sub> N <sub>4</sub> , PSG, Al <sub>2</sub>
Glass	Borosilicate glass, glass solder
Magnetic materials	AlNiCo, SmCo, ferrite, soft magnet material
Ceramics	Al <sub>2</sub> O <sub>3</sub> , AlN, PZT, α-SiO <sub>2</sub> , LiNbO <sub>3</sub>
Chemical materials	Liquid and solid electrolytes, metal oxides, organic compounds, optic indicators
Plastics	Polyimide, PMMA, epoxide
Biological materials	Enzyme, proteins, biologic substrates, microorganisms
Metals	Steel, aluminium, copper, silver, gold

Silicon, plastics and diverse metals are the most common materials used for the manufacturing of MEMS, further materials are used in more specific application fields.

The very well investigated silicon technology allows the integration of mechanics and electronics on a chip („monolithic integration“) with high availability and quality at reasonable costs. Semiconductor materials enable the use of sophisticated manufacturing methods from microelectronics, the integration of electrical and other functional components and a multiplicity of effects linking electrical and non electrical signals [7].

Plastics are used in a wide range of application in MEMS. In addition to housings and covers they particularly provide structure carriers in MID technology. Crucial factors for the selection of a suitable plastic in addition to technological aspects are mechanical, thermal, electrical and chemical characteristics needed in the desired application area. Despite unfavourable characteristics of polymer structures in view of thermal and mechanical strength, they are highly competitive when manufactured by micro injection moulding in large lot sizes and allow a wide range of application with structured layers of metal. Typical polymers used for MEMS are PMMA, POM, PC, PEEK or LCP [8].

Metals provide a rich variety of useful characteristics for both mechanical and electrical parts, e. g. housings or electrical interconnections [7].

Most MEMS engineering effects are based on a conversion of signals and/or an energy transformation. The desired function is often disturbed by unintended side effects. Thus the development of MEMS requires material data clearly beyond characteristic values needed in partial disciplines. Furthermore the supply with material-specific values is a serious problem in MEMS engineering, since exact specification of boundary conditions concerning technical data is often missing in technical literature. Simple transfer from macroscopic specifications to thin layers is not possible [6]. Constantly new materials and manufacture parameters require specific investigations to find adequate materials and manufacturing processes [9].

## 2.2 Manufacturing processes

Multiple demands on structuring and materials in MEMS technology require various manufacturing technologies as shown in Figure 1.

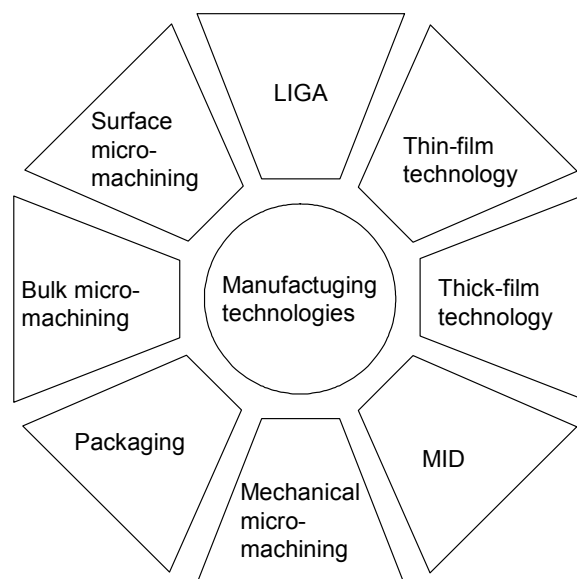

Figure 1. Selection of MEMS manufacturing technologies [3], [7], [8]

Silicon manufacturing technologies usually descend from procedures working satisfactorily in microelectronics (LIGA, bulk micromachining, thin-film technology, thick-film technology, surface micromachining), although Microelectronics manufacturing is 2D while MEMS is a 3D process. They are based on the separation of layers and structuring by lithography and etching [7], [8]. Recently the importance of micro injection moulding of ceramics and metals is increasing (PIM - Powder Injection Moulding, CIM - Ceramic Injection Moulding).

Micro machining allows metal cutting and EDM (Electrical Discharge Machining) operations of microstructures with excellent accuracy. Mechanical micromachining is often used for chip removing processing of metals down to 30  $\mu\text{m}$  (drilling) with an accuracy of  $\pm 2 \mu\text{m}$ . Micro wire EDM uses wire diameters down to 20  $\mu\text{m}$  with achievable aspect ratios of grooves from 60 to 80  $\mu\text{m}$  [10].

MID technology allows quite free and economical shaping based on die casted plastic work-pieces with metallized surfaces. The dimensions of the carrier depend on the limits of mould manufacturing, material and injection moulding process. The metallized surface usually consists of electro-plated layers of diverse metals, e. g. copper-nickel-gold for conductive coatings, structured by laser with pitches down to 50  $\mu\text{m}$  [8], [11].

Packaging provides contacting and integration of the individual components. In many cases manufacturing methods are also combined in order to manufacture a MEMS. A common practice is to manufacture separate components in different manufacturing processes and to integrate and contact them on a substrate afterwards (hybrid integration). The integration requires attention to various aspects of e. g. thermal and mechanical dimensioning [4].

### 3 Design rules in the MEMS development process

The miscellaneous manufacturing techniques call for a careful choice of the manufacturing process [2]. Simultaneous development of product and manufacturing process requires knowledge management supported by adequate methods [3], [5], [9]. Both methodology in general and design rules in particular are important in this context.

#### 3.1 Development process for MEMS design

MEMS design is enhanced by support of a well adapted design procedure and requires a specific methodology with focus upon the characteristics of this discipline [5], [9]. Integrated methods for DFX-support encourage this effect [9].

A proposal for a new MEMS design methodology based on the VDI guideline 2206 [12] for development in mechatronics is shown in Figure 2.

This general development process starts with the generation of a system concept that is continued by a parallel development of the system components in diverse domains and the manufacturing technology. The concluding system integration verifies the desired characteristics of the product. The development process is embedded in the product lifecycle to incorporate knowledge and demands from different stages of the products life. This general process must be precisely specified and adapted for the demands of specific product developments.

The development process in a narrower sense can be superposed by different views on the process, e. g. quality demands or economic aspects.

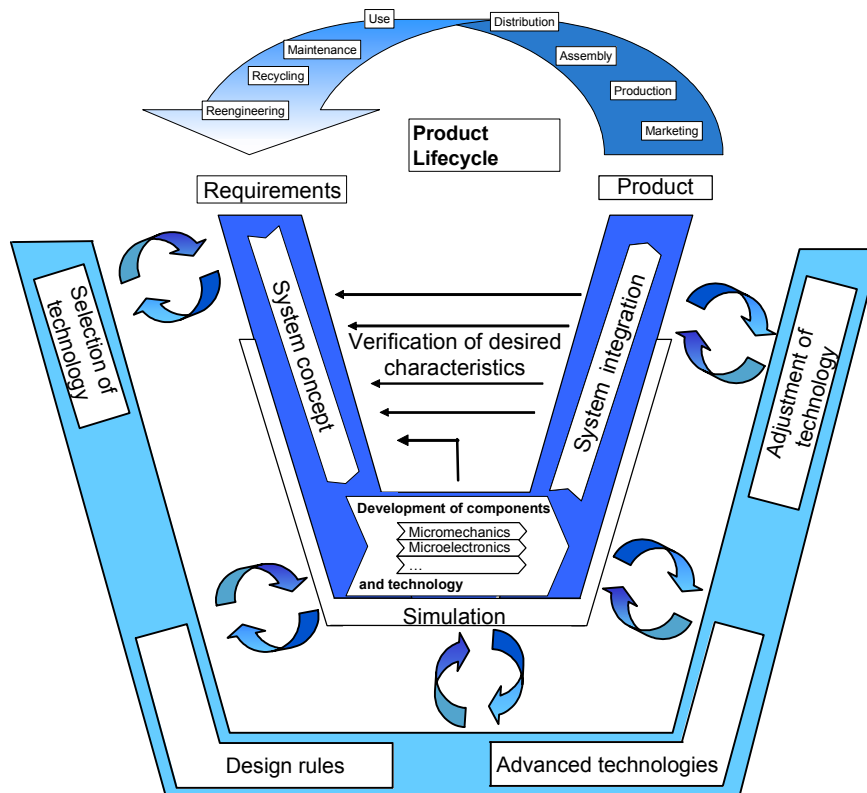

Figure 2. Design process for MEMS, based on [3]

Simultaneous development of both product and manufacturing technology influence each other and must be regarded in the development process. Thus the basic development process in Figure 2 is superposed by a manufacturing view showing manufacturing issues affected during the development process:

- selection of the manufacturing process at the beginning of the development
- design guidelines based on the manufacturing process to support the shaping of MEMS
- interaction between development of the product and advanced manufacturing technologies
- adjustment of technology based on results of system detailing

The two first aspects are enhanced in the following paragraphs.

### 3.2 Selection of the manufacturing technology for MEMS

The decision for an adequate manufacturing technology mainly comes from the analysis of the requirements list and the basic system concept.

The choice of an adequate manufacturing technology is based on the material, quantities, cost aspects, fundamental shape considerations as well as available and favoured production equipment. Figure 3 illustrates different points of view on the choice of the manufacturing technology.

Requirements on MEMS manufacturing technology		
Production	Use	Economy
<ul style="list-style-type: none"> <li>• Required Tools</li> <li>• Process time</li> <li>• Geometry</li> <li>• Limits of technology</li> <li>• 2D / 3D Dimensions</li> <li>• Number of pieces</li> </ul>	<ul style="list-style-type: none"> <li>• Temperature</li> <li>• Heat dissipation</li> <li>• Operating Voltage</li> <li>• Operating current</li> <li>• Environmental conditions</li> </ul>	<ul style="list-style-type: none"> <li>• Lot size</li> <li>• Number of versions</li> <li>• Material costs</li> <li>• Manufacturing costs</li> <li>• Assembly costs</li> <li>• Sales price</li> </ul>

Figure 3: Examples of requirements on MEMS manufacturing technology

The various influences on the manufacturing technology make the selection more complicated and cause more requests of MEMS designers about manufacturing aspects compared to macro designers [5]. Design rules provide an adequate support of the development process.

### 3.3 Design rules

#### 3.3.1 General approach to design rules for MEMS

Design for manufacturability includes manufacturing issues into the design process. MEMS design requires the consideration of basic design principles [5], [9], [11]:

- *Minimize the number of components.*  
Fewer components means fewer masks, molds, less material, reduced assembly, less processes, function sharing structures.
- *Use standard components.*  
Allows use of standard manufacturing and assembly processes, reuse or redesign of parts, larger lots, fewer parts.
- *Modular design.*  
Enables clear interfaces, simple assembly of complex systems, automated assembly, reuse of parts.
- *Standard manufacturing process.*  
Reuse for multiple MEMS products, higher utilisation of production facilities, lower costs.
- *Ease of manufacturing.*  
Standard materials, simple manufacturing processes, few process steps, simple geometry.
- *Use of standard interfaces.*  
Rationalizes quality testing, enables combination of modules.

Beyond these general design rules applicable to every MEMS development project there are specific rules necessary for several manufacturing technologies.

The following statements about MID design rules give an example for the configuration of specific design rules.

### 3.3.2 Design rules for the MID manufacturing process

The design of MID-based MEMS is influenced and limited by several factors, Figure 4.

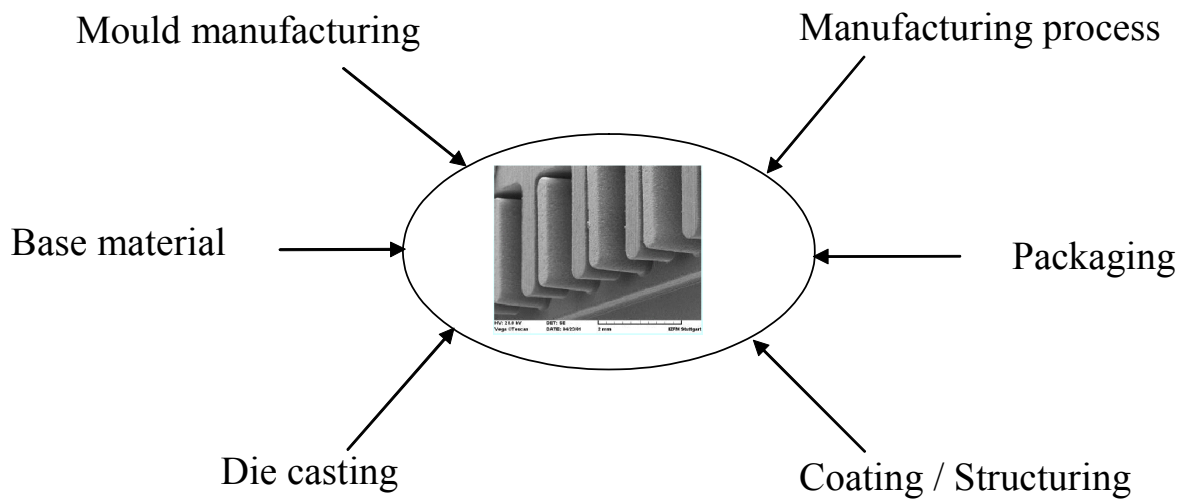

Figure 4. Influences on the design of MID-based MEMS components [Picture: IZFM]

According to the manufacturing sequence, the manufacturing of the mould is the first aspect to keep in mind. Die casting moulds are usually manufactured by metal cutting or EDM micro machining operations with primarily geometrical limitations e. g. concerning aspect ratios (width/depth) and minimum diameters or curves but economic aspects as well. The base material of the product varies by costs, machinability particularly depending on the mould and the die casting process and boundary conditions of the application field of the product, e. g. temperature or deterioration. The die casting process must enable a complete form filling with smooth surface roughness and small tolerances. This requires the consideration of micro-rheological effects by simulation and experience.

Coating and structuring processes are limited by minimum or maximum thickness of coated layers, geometric limits of the coating process, e. g. depth of grooves or sharpness of edges, and the laser structuring process, e. g. minimum pitch, penetration depth or angle of chamfers.

The assembly process of MEMS is usually realised automatically. Assembly direction, packaging and bonding technologies, geometrical limitations and further aspects influence the feasibility and complexity of the assembly process.

The operability, complexity and sequence of the complete manufacturing process are mainly influenced by the design of MEMS components. The consideration of the interrelation between all phases of the manufacturing process is a basic condition for the successful design of low-cost and high-quality components demanded for MEMS technology.

All of these influences can be covered by design rules to support the designer in deciding on geometrical, functional and other parameters of new products. Examples for general guidelines supporting the development are given in [5].

Data sheets with design rules have to be updated continuously due to advances in manufacturing technology. An example for a data sheet with design rules for surface structuring is shown in Figure 5.

Design rules	Coating structure	coating / structuring
MID		Wa 02/2005

	2K-injection moulding	Hot embossing	Mask structuring	Laser- structuring	In-Mold-Decoration (IMD)
Cu-coating min. [ $\mu\text{m}$ ] max. [ $\mu\text{m}$ ]	1 50	12 150	5 70	9 50	15 70
Surface finish min. [ $\mu\text{m}$ ] max. [ $\mu\text{m}$ ]	Ni Au 1 0.1 12 0.8	Ni Au 1 0.1 5 2	Ni Au 1 0.1 12 1	Ni Au 3 0.1 5 0.2	Ni Au 1 0.1 5 1
coating area max. [ $\text{cm}^2$ ]	limited by bath size	lim. by foil and adjoin	2500	400	75% of foil area
z-extension max. [mm]	200	limited by adjoin	230	200	200
Pitch min. [ $\mu\text{m}$ ]	250	200	125	80	100
Pitch Distance min. [ $\mu\text{m}$ ]	250	300	125	40	100

Figure 5. Design Rule data sheet

The area of influences on MEMS manufacturing is widespread and still unexplored in many fields. A successful start has been made with MID manufacturing technology, but more areas are coming up and so gathering and preparation of this information are still in the beginning and the enlargement is going on. Especially the continuously advancing manufacturing technologies require further work in the field of DFM.

## 4 Integration of MEMS

### 4.1 Integration requirements

MEMS technology closely integrates diverse disciplines of physics, e. g. micro mechanics, microelectronics, micro acoustics, micro optics and micro fluidics, as well as microbiology and microchemistry, Figure 6.

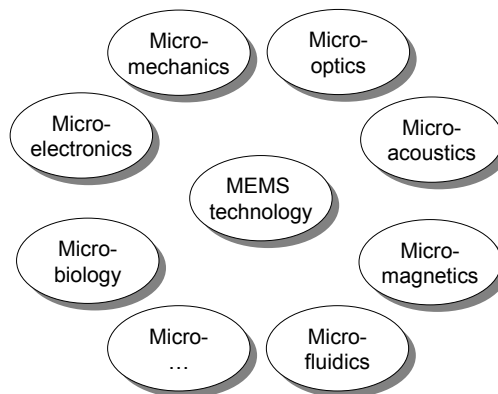

Figure 6. MEMS disciplines [13]



A good understanding of physical background, material, manufacturing process, overall concept and desired signal transmission is an essential precondition for any change of dimensions.

Miniaturization and integration cause influences between MEMS components and result in physical effects. A smaller surface-volume-ratio may cause cooling problems and the mechanical properties of a system may change due to the fact that mechanical stiffness increases with smaller dimensions [14]. Electromagnetic effects enable electrostatic micromotors but also cause lubrication problems [15] or deflection [16] and undesirable parasitics in small systems.

The designer must verify assumptions and consider new influences when he designs highly integrated technical system. The reduction of these impacts requires their consideration in the development process by use of adequate methods accepted by designers in practice.

#### 4.2 Implementation of the working structure as integration method

The importance of the geometric and material parameters for the function of mechanical, electronical and optical design was pointed out by Jung [17], [18]. He introduced the “geometry function principle” and constituted the importance of the correlation between geometric and material parameters as well as internal and external influences on the function of a system, Figure 7.

In order to consider all influences and interrelations, it is necessary to get a clear view of the geometric combination of fundamental elements as well as the effects of used materials and influencing operation parameters.

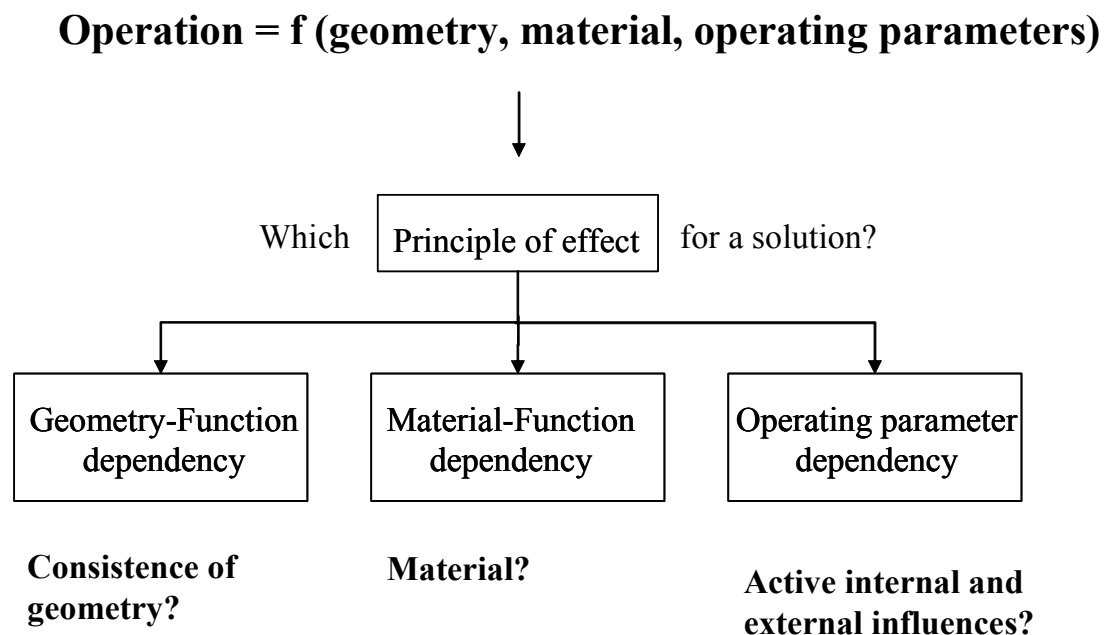

Figure 7. Principle of effect, based on [18]

The relation between geometry and function is essential for the development of MEMS, but different from other technical areas [5]. The function structure established in mechanical engineering [19] enriched by geometrical, material and operation characteristics of the solution enables a comprehensive view on MEMS and their internal and external functional interrelations.

The new developed working structure illustrates geometric and material parameters of the components of a system and their mechanical connection. Connections are illustrated by symbols representing their degree of freedom, Figure 8.

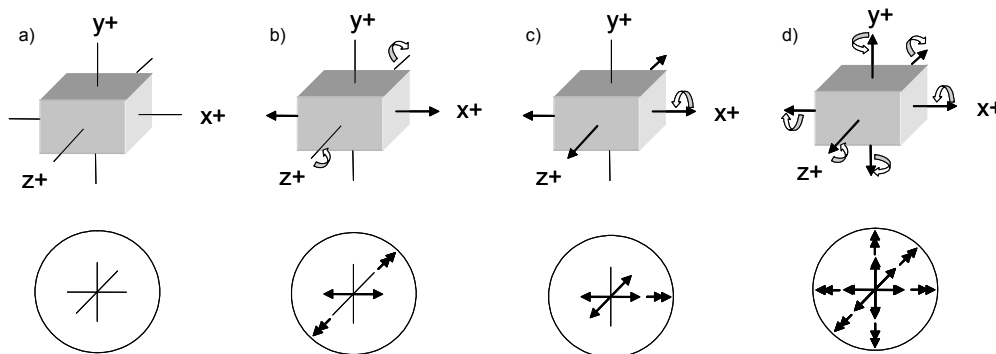

Figure 8. Illustration of rotatory and translatory degrees of freedom

Illustration (a) shows a fixed connection without possible motion. Full rotatory and translatory motion is represented by (d), whereas (b) and (c) allow partly translatory and rotatory movement.

This graphical representation of a system is supplemented with internal and external influences. Figure 9 shows the new developed working structure of an incremental encoder as an example.

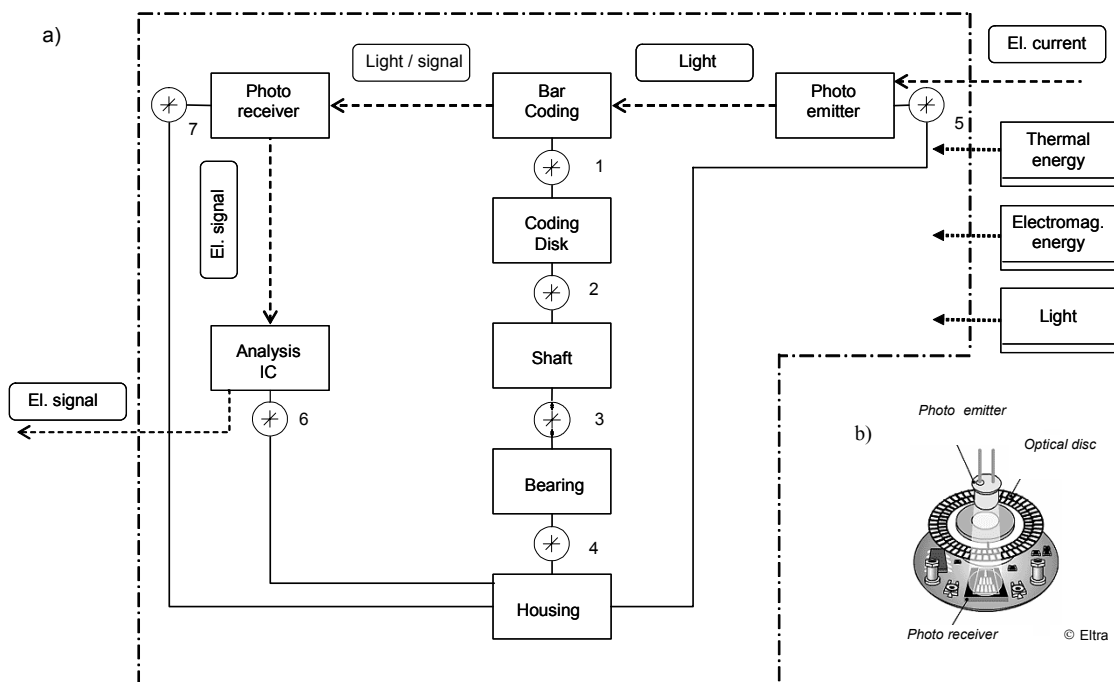

Figure 9. Rotary incremental encoder

- a) working structure
- b) functional principle

The illustration by the working structure supplies a holistic view on complex systems. A complete overview of all components of a MEMS enables the review of system elements and their interrelations during the development process.

### 4.3 Review of system interrelations

The analysis of e. g. physical, geometrical or functional interactions between components of the system and its environment is supported by a matrix based on the working structure.

The Design Structure Matrix (DSM), also known as Dependency Structure Matrix is a compact matrix representation of a system or project. DSM was initially introduced by Warfield [20] and used in numerous cases, e. g. for the integration of large scale systems by Eppinger [21]. The DSM consists of a sequence of system components that are represented in the same order in both row and column of the matrix. The central part of the matrix shows the dependencies between the components.

The integration analysis of a system consists of three steps [21]:

1. Record the system configuration.
2. Document the interactions in a matrix.
3. Analyze the matrix to identify the structure of interactions.

The DSM represents the system structure and helps to get a clear view of its configuration. All parts, connections, flows and external or internal influences are documented in the rows and columns of the matrix. The nature or material of one of these parameters can be added in the beginning or during the structure identification process. Influences and inter-actions are documented by arrow pointing to the parameter in the column. Thus all influences on e. g. a system component become quite obvious by considering the corresponding row. On the other hand all influences coming from e. g. an external influence are centralized in one column. This enables the designer of a component to consider all influences and to be sure to gather all information from other domains influencing his work. Figure 10 illustrates the DSM for the working structure of the rotary incremental encoder in Figure 9.

Design Structure Matrix	Nature / material	Photo receiver	Bar coding	Photo emitter	Coding disk	Analysis IC	Shaft	Bearing	Housing	Connection 1	Connection 2	Connection 3	Connection 4	Connection 5	Connection 6	Connection 7	El. Current	Light current	Light / signal	El. signal	Thermal energy	Electromag.energy	External light	
Photo receiver				←												←		←	←			←	←	
Bar coding		←		←	←	←					←											←		
Photo emitter		←												←			←							
Coding disk			←							←	←													
Analysis IC		←	←												←					←	←	←		
Shaft					←					←	←													
Bearing	radial						←		←			←	←										←	
Housing	plastic	←		←	←	←		←					←	←	←	←		←	←		←	←	←	
Connection 1	lasered		←																					
Connection 2	adhesive				←		←																	
Connection 3							←	←																
Connection 4								←	←															
Connection 5				←					←															
Connection 6	adhesive					←			←															
Connection 7		←							←															
Light current				←																				
Light / signal		←	←	←	←																			
El. signal		←				←																		←
Thermal energy								←	←															
Electromag.energy		←		←	←																			
External light																								

Figure 10. Design structure matrix of a rotary incremental encoder

The matrix shows influences between components and their connections as well as external influences of e. g. thermal energy. It enables mechanic, optic and electronic designers to work together and to find interrelations between them and to e. g. manufacturing engineers.

Looking at the appropriate component in the first column, influences of e. g. other components can be easily regarded in the row of the matrix. On the other hand impacts of a component or external influence on other parts of the system can be found by considering the arrows in the associated column. The matrix also shows components and their direct connections by shaded fields.

This procedure was applied in three development processes with very good results. The experience proved that more aspects were considered in order to optimise quality, overall function and manufacturability of the developed MEMS.

## 5 Conclusion

MEMS development differs significantly from development in other domains. It requires not only adapted development processes but also appropriate methods to enable the development of products with high quality at reasonable prices.

Two elements based on a fundamental development process for MEMS development have been introduced. An approach to DFM and design rules supports the geometrical and functional design of manufacturable MEMS components. A new method for system integration of MEMS based on working structures and DSM matrices simplifies the consideration of integration aspects important for MEMS development.

The results obtained are promising and they open up demand for further DFX-guidelines. The evaluation of the developed guideline showed acceptance and usability in practice.

Adoption of the method and the content to further fields is necessary. Design rules have to be collected with respect to the particularities of the manufacturing processes and to influences of new materials and technologies. The high grade of integration requires further support by methods. Both areas should be enriched by use of computers to store and provide knowledge.

The relatively new and expanding field of MEMS technology becomes more and more structured, but there are still many white spots on the map.

## References

- [1] Nexus: The NEXUS product-technology roadmap for Microsystems. Grenoble: The NEXUS Association 2003
- [2] Cui, Z.; Leach, R; Flack, D; Brenner, W. et al.: Microsystems Technology Standardisation Roadmap. Teddington, UK: National Physical Laboratory 2003
- [3] Binz, H.; Watty, R. et al.: Improved design and development process for MEMS sensors. Proceedings of the Eurosensors XVIII Conference, Rome, Italy: September 2004
- [4] Kasper, M.: Mikrosystementwurf. Berlin: Springer 2000
- [5] Klaubert, H.: Tiny design: A study of the design of microelectromechanical systems. PhD-thesis, Cambridge University 1998

- [6] VDI/VDE-Technologiezentrum Informationstechnik GmbH (Hrsg): Untersuchungen zum Entwurf von Mikrosystemen, Abschlussbericht zum Verbundprojekt 1992-1994, Teltow, 1994
- [7] Madou, M.: Fundamentals of Microfabrication. Boca Raton: CRC Press LLC 2002
- [8] Kück, H.: Mikrotechnik. Lecture Notes, Universität Stuttgart 2004
- [9] da Silva, M.: Design For Manufacturability for 3D MicroDevices. NSF Workshop on Three-Dimensional Nanomanufacturing: Partnering with Industry. Birmingham, Alabama, January 5-6, 2003
- [10] Zumtobel Staff GmbH: Data sheet micromachining. www.zumtobelstaff-werkzeugbau.com, Dornbirn, Austria: 2003
- [11] Pöhlau, F.: Entscheidungsgrundlagen zur Einführung räumlicher spritzgegossener Schaltungsträger (3D-MID). Dissertation Friedrich-Alexander-Universität Erlangen-Nürnberg 1998
- [12] VDI: Design methodology for mechatronic systems, VDI 2206. VDI Guidelines, Berlin: Beuth 2004
- [13] Binz, H.; Watty, R.: Anforderungen an den Entwicklungsprozess in der Mikrosystemtechnik, 2. Gemeinsames Kolloquium Konstruktionstechnik, Dresden 2004
- [14] Roth, K.: Physikalische Zusammenhänge bei der Veränderung der Größe eines technischen Objekts. Proceedings ICED 91, Zürich 1991
- [15] Chapman, P.L.; Krein, P.T.: Micromotor Technology: Electric Drive Designer's Perspective. 36th IEEE Industry Applications Society Annual Meeting. Chicago, USA October 2001, pp. 1978-1983
- [16] Gilbert, J. R.: 3D Coupled Electro-mechanics for MEMS: Applications of CoSolve-EM. Proceedings of MEMS 95, Amsterdam 1995, pp. 122-127
- [17] Jung, A.: Geometrisch-Funktionales Denken – Grundlage funktionaler Gestaltung. Proceedings ICED 88, Budapest 1988
- [18] Jung, A.: Geometrie, Stoff und elektrische Funktion, Zur Didaktik des geometrisch-funktionalen Denkens. Proceedings ICED 91, Zürich 1991
- [19] Pahl, W.; Beitz, G.: Engineering design: a systematic approach. Berlin: Springer 1995
- [20] Warfield, John N.: Binary Matrices in System Modeling. IEEE Transactions on Systems, Man, and Cybernetics, vol. 3, pp. 441-449, 1973
- [21] Eppinger, S.: A planning method for integration of large-scale engineering systems. Proceedings ICED 97, Tampere 1997

### **Acknowledgements**

Research about development processes in specialized subjects like Microsystem technology is not possible without help of MEMS experts. We were strongly supported by the technology expertise of Prof. Dr. rer. nat. Heinz Kück and his team, namely Dipl.-Ing. Daniel Warketin and Dipl.-Ing. Daniel Benz, from the Institute for Microsystem Technology (IZFM) of the University of Stuttgart and would like to acknowledge their contributions.

Robert Watty  
University of Stuttgart  
Institute of Machine and Gear Unit Design  
Pfaffenwaldring 9  
D-70569 Stuttgart  
Germany  
Phone: ++ 49 (0)711 685-6040  
Fax: ++ 49 (0)711 685-6219  
E-Mail: [watty@imk.uni-stuttgart.de](mailto:watty@imk.uni-stuttgart.de)  
Internet: <http://www.imk.uni-stuttgart.de>